

SKIPPER

EML224 Compact

CD401 124/224 Speed Log Operation Manual



SKIPPER Electronics AS
Enebakkveien 150
P. O. Box 151, Manglerud
0612 Oslo, Norway
www.skipper.no

Telephone: +47 23 30 22 70
Telefax: +47 23 30 22 71
E-mail: support@skipper.no
Co. reg. no: NO-965378847-MVA

Document no: DM-E003 -SB
Edition: 2011-12-16
Rev: 1.11

EML**124/224 SPEED LOG
COMPACT VERSION**

OPERATION MANUAL

December 2011

Edition 2011-12-16 Sw. 1.11

Weitergabe sowie vervielfältigung dieser unterlage, verwertung und mitteilung ihres Inhaltes nicht gestattet, soweit nicht ausdrücklich zugestanden. Zuwiderhandlungen verpflichten zu schadenersatz.

Toute communication ou reproduction de ce document, toute Exploitation ou communication de ou son contenu sont interdites, sauf autorisation expresse. Tout manquement à cette règle est illicite et expose son auteur au versement de dommages et intérêts.

Copying of this document, and giving it to others and the use or communication of contents thereof, are forbidden without express authority. Offenders are liable to the payment of damages.

Sin nuestra expresa autorización, queda terminantemente prohibida la reproducción total o parcial de este documento, así como su uso indebido y/o su exhibición o comunicación a terceros. De los infractores se exigirá el correspondiente resarcimiento de daños y perjuicios.

SKIPPER

Electronics AS

COMMUNICATING WITH US

If you need more information, support or other assistance from us, do not hesitate to contact us:

SKIPPER Electronics AS
P. O. Box 151, Manglerud
NO-0612 Oslo
Norway

Phone: (+47) 23 30 22 70, Fax: (+47) 23 30 22 71
E-mail: sales@skipper.no

SOFTWARE UPDATES AND TECHNICAL SUPPORT

Find us on the internet: www.skipper.no

YOUR FEEDBACK IS APPRECIATED

If you find errors, misspellings or poorly explained sections in this document, please do not hesitate to contact us at:

support@skipper.no

TABLE OF CONTENTS

Terminology	5
Units	5
Abbreviations	5
CHAPTER 1 Introduction	6
Interconnection Diagram	7
Chapter 2 CALIBRATION	8
The Principles	8
Calibration modes	9
Checking the calibration	11
Chapter 3 ROUTINE OPERATION	12
Runtime screens	12
Menu screens	12
Alarms	12
Setup of alarms	13
Runtime Diagram	14
Master Reset (Factory Default Settings)	15
Menu Diagram	16
Notes:	18

TERMINOLOGY

UNITS

Unless otherwise stated, all values shown on the display are as follows:

Distance	Nautical miles (nm)
Speed	Nautical miles per hour (kn)
Pulse indication	Pulses per nautical mile (p/nm)
Temperature	Degrees Celsius (°C)

ABBREVIATIONS

In addition, the following symbols are used on the runtime screens:

Tp	Daily trip (in nm)
TL	Total measured distance travelled
°	Degrees centigrade
STW	Speed through water
TRIP	Text for trip/total
SOG	Speed over ground
TEMP°	Text for TEMPerature

CHAPTER 1 INTRODUCTION

The SKIPPER EML 224 Compact is a device that uses the effects of magnetism in moving water to measure the speed of a vessel in one or two axis. This effect is well understood and provides reliable data of the speed of the vessel through the water. This information is normally not available from any other sensor on board, and gives the navigator valuable information as to how currents are effecting the motion of the vessel. The EML system comprises of four main parts:

1. **The mounting**; Either a Sea Valve or tank. Welded to the bottom of the hull.
2. **The sensor**; A speed sensor device designed to fit into the mountings.
3. **The Electronic unit (JB60CD)**; The JB60CD allowing the EML 224 Compact to be powered and interfaced to the other navigation systems using digital standards.
4. **The EML 224 Compact display**; An alphanumeric display unit allowing the bridge staff to view the data.

The EML 224 Compact is unique in its simple, yet flexible way to display vital data in almost all conditions.

For more detailed information regarding installation and system settings refer to the operation and installation manual.

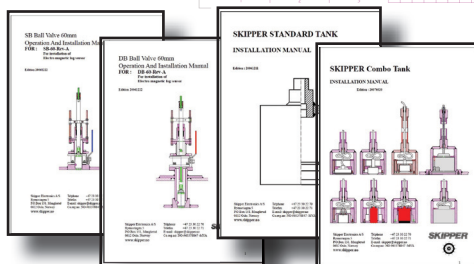
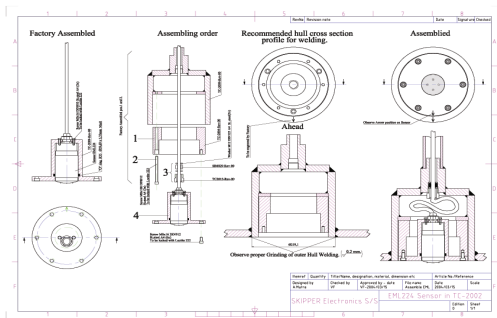
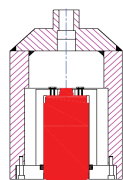
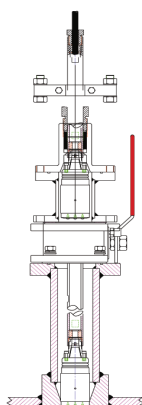

Manuals available from www.skipper.no

INTERCONNECTION DIAGRAM

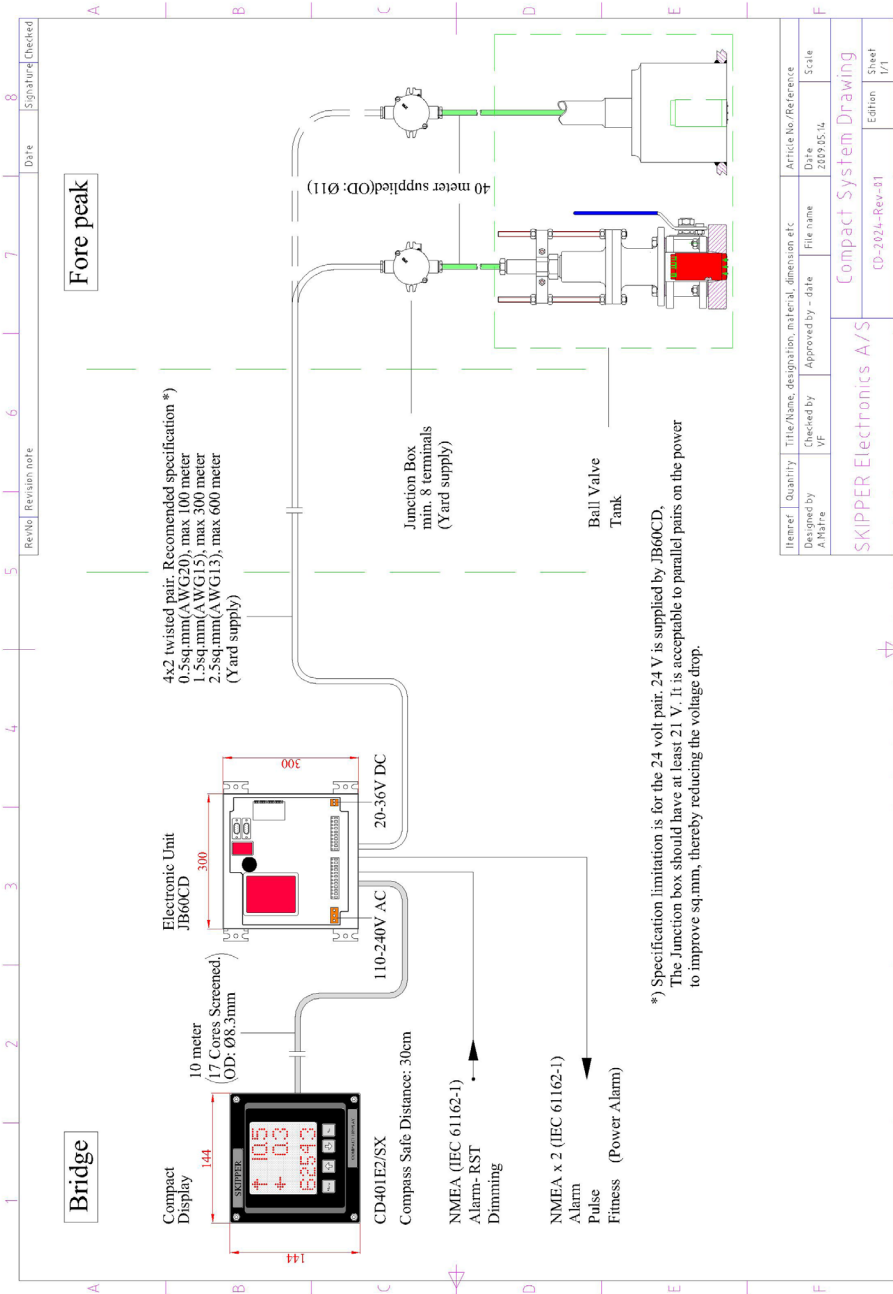

CHAPTER 2 CALIBRATION

THE PRINCIPLES

Calibration of a speed log involves finding the mounting angle of the sensor (heading offset) and the speed error, at various speeds. If the vessel has a laminar water flow near the sensor, a single calibration point will be sufficient. If the flow changes with speed, (due to the friction of the hull, or nearby constructions) then extra calibration points will be required. The sensor is mounted on a pole that can be turned to adjust the angle. This may result in a small angular error. This can be calibrated away in the 2 axis version. This should be done before the main calibration procedure is performed.

Calibration parameters

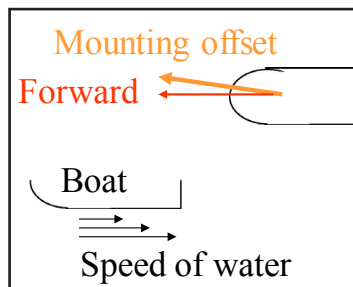

Full calibration is designed to ignore water current effects. The procedure requires the vessel to sail a fixed length track, at a constant speed. To remove the current and wind effects, the same track should then be sailed in the opposite direction.

The average of these tracks will be used to calculate the speed difference between the real speed (measured using the actual distance and the time it took), and the measured speed (using distance from the sensor and the time it took). This procedure must be performed at least once, and then other speeds checked with the GPS.

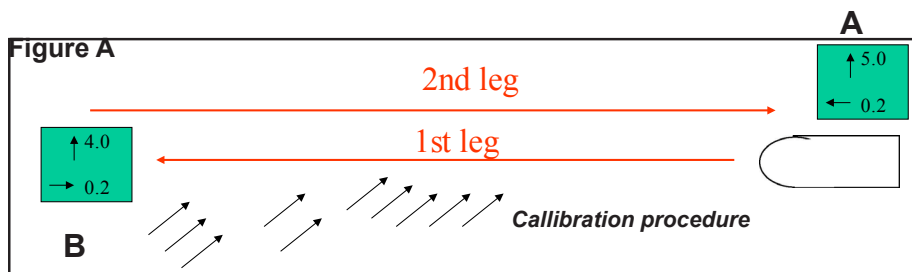

If necessary, the procedure should be repeated at different speeds. SKIPPER recommend that calibration is performed at a low speed and a high speed. If the user is not able to turn the vessel and is sure there is no current, the calibration

procedure can be stopped after the first leg and saved as a calibration point. This will give values that are correct for that particular condition. (If current is present, the speed through water will contain an error).

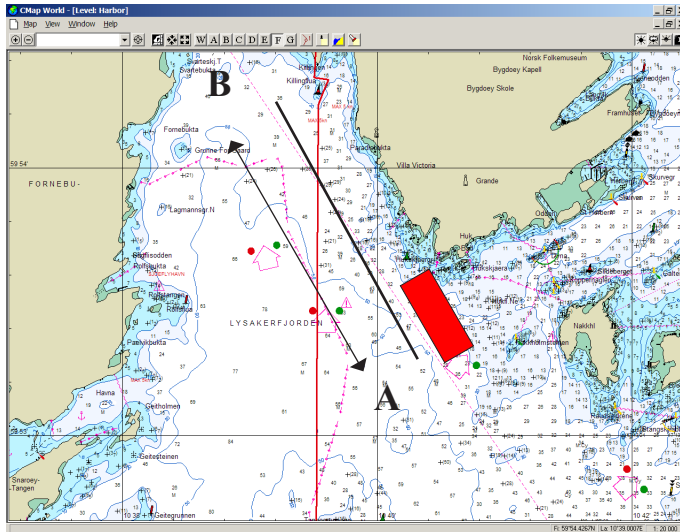

Figure B
Shows plotting a calibration path on the chart.

The leg should take at least 5 minutes to sail (distance can be shorter when sailing slowly).

CALIBRATION MODES

The EML 224 Compact has two modes of calibration:

1. Manual
2. Semi-automatic.

Manual mode

The calibration – (MANUL) menu will allow the user to adjust the heading offset (*see note below), and the speed calibrations individually. Up (↑) and down (↓) adjust the highlighted parameter. SET moves to the next parameter. The data showing the result of the change will be displayed dimmed on the same screen (offset or speed). On the 3rd press, the lower value will change from Measured or Raw resultant value (Mrs) to Calibrated resultant (Crs) to allow the user to check the result of the change.

Procedure

When entering the manual mode, you will be presented with the offset value. This is the mounting angle of the sensor. The bottom line shows the measured offset at this moment. Adjust the middle value until the bottom value is near zero.



Note the bottom value has a long average, and you may have to wait for up to a minute for the value to stabilise. **Note:** This function is only available in twin axis systems*

Hint: Pressing down (↓) and SET together will change the current selected value to the resultant value, or to zero, saving time when adjusting.

Pressing SET moves you to the next speed calibration. Enter the real (R) speed and measured (M) speed, (the measured speed can be seen on the bottom line). The calibrated value can be checked by pressing SET one more time. Repeat this process at as many different speeds as necessary.

Semi-automatic mode

The calibration – AUTO menu will take the user step by step through the calibration menu. The user may follow the steps presented on screen. First drawing a line on the chart system, as shown in figure A & B.

- The line should be sailed at constant stable speed and the the line should represent at least 5 minutes of sailing at the current speed.
- **Leg length setting.** (Adjust the length to match the line drawn on the chart).
- **Start first leg.** (The vessel crosses point A at the calibration speed, towards point B).
- **Stop first leg.** (The vessel reaches point B on the chart and turns to sail the line in the other direction).
- **Save first leg.**(If the presented speeds look correct, save the leg and continue).
- **Second leg option.** (If you do not have the possibility to turn the vessel, you can use the first leg data directly. If the first leg data is of poor quality you may not be given the option to continue).
- **Start second leg.** (The vessel crosses point B sailing towards point A, sailing at the same speed as leg 1).
- **Stop second leg.** (press as the vessel passes point B)
- **Calibration result and save option** (The user can decide to accept or reject this calibration, and in which memory position to save it).



Note: The user should press the start and stop based on position on the chart, and not sailed distance on the unit..

The user may decide which of the 10 calibration points the calibration will be saved in. The screen will display the first available position on the table, or overwrite from zero upwards.

Note: The single axis version (CD401E1) of this product does not have the transversal axis available and will not require offset calibration. However, it is highly important that the unit is mounted pointing forward. If mounted in a valve, the pole can be rotated whilst moving the vessel against any current to maximize the longitudinal speed. This should be ahead.

CHECKING THE CALIBRATION

To check that the calibration points are not too far from the ideal linearity, the Calibration – GRAPH menu will plot the calibration points on the screen. The user may use up (↑) and down (↓) to select a calibration point and then adjust that value by pressing SET on the relevant point. The MENU button will return you to the GRAPH menu again.

Calibration should occur or be checked whenever the sensor is moved, or a new sensor is mounted. If there is growth on the sensor over time, the speed may be reduced slightly. The system should then be re-calibrated.

Note: *If a new sensor is mounted, the calibration in the EML 224 Compact may be useable. However, it should be checked.*



CHAPTER 3 ROUTINE OPERATION

RUNTIME SCREENS

The EML 224 Compact starts up in run mode. By pressing the MENU button, the preset user screens can be selected. (See [“Runtime Diagram” on page 14](#)). Some of the menu screens (i.e alarms) are also available in the run mode.

The EML 224 Compact can be dimmed in any of the run screens using the up (↑) and down (↓) buttons.

If Trip/Total are selected as a displayed parameter, they can be toggled using the SET button.



SETUP SCREENS

To change the setup of the EML 224 Compact, the user must simultaneously press MENU and SET. This will give access to a menu system allowing the user to scroll up and down the sub-menus and functions using up (↑) and down (↓), and SET to select. To move to the previous menu, the MENU button must be pressed. The middle underlined line is the selected line, the other lines are dimmed.



The menu structure is shown in the [“Menu Diagram” on page 16](#). The menus are product dependant, only the relevant menus are accessible. However, some menus are always available. Most setup screens are configured during installation. The user will only need to occasionally adjust calibration.

ALARMS

The EML 224 Compact system contains one software alarm output and one reset alarm input.

- **Speed high** and **Speed low** alert the user when the vessel exceeds the speed limits.
- **Sensor alarm** is a system error alarm that activates if a serious system error occurs.

- **Fitness alarm** is a digital output, which if activated, sends a pulse each time a button is pressed on the display.
- **Power failure alarm**. If fitness alarm is deactivated, the output becomes a **Power failure alarm** which indicates a Power failure in the system. The output will show a high voltage at all times unless if there is a Power failure.

SETUP OF ALARMS

When operating as a primary source, the EML 224 Compact can be made to give an alarm in some conditions. These can be adjusted in the Alarms menu page. Values are changed with up (↑) and down (↓). The different alarm types can be selected by selecting from the menu, or by pressing SET to move to the next alarm.

When an alarm is activated, the alarm type will flash on the screen, and a signal will be sent to the external alarm system. The EML 224 Compact does not contain an internal alarm beeper. If required, an external alarm beeper can be wired to the alarm relay. Alarm protocol follows the IMO (International Maritime Organization) regulations and OSV (Offshore Vessel) requirements and can be silenced remotely. To remove the alarm warning from the screen, a button must be pushed on the EML 224 Compact. According to newer regulations, the system should keep an alarm indication at all times if the system is measuring an alarm state.

If the vessel is sailing faster than the preset high speed, the message '**SPDHI**' will flash until the external alarm reset is set. It will then show a constant inverted text **SPDHI** until the alarm is acknowledged on the EML 224 Compact display. If the vessel is still sailing fast, (over the alarm limit) the EML 224 Compact display will have a large square in the top right corner. This will only disappear when the vessel sails slower than the alarm speed again.



RUNTIME DIAGRAM

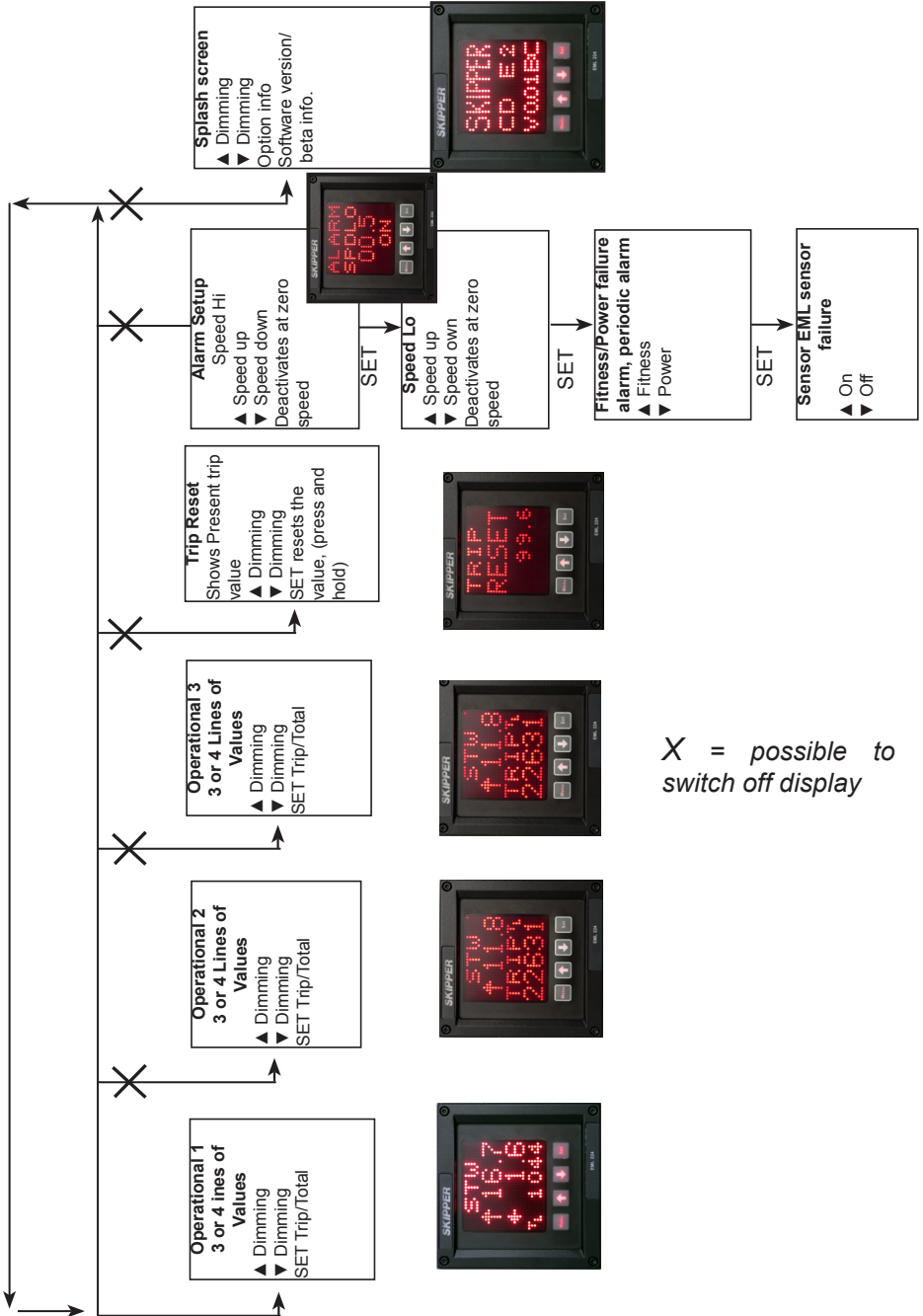

MASTER RESET (FACTORY DEFAULT SETTINGS)

The factory default settings can be restored by performing the following operations:

1. Select CODE in diagnostic (DIAG) menu.
2. Press the SET button (**Note:** Do not change code value, just press the SET button.)

The unit will now restart with factory default settings.

Note. On EML systems, this will also **reset** the stored calibration values.

MENU DIAGRAM

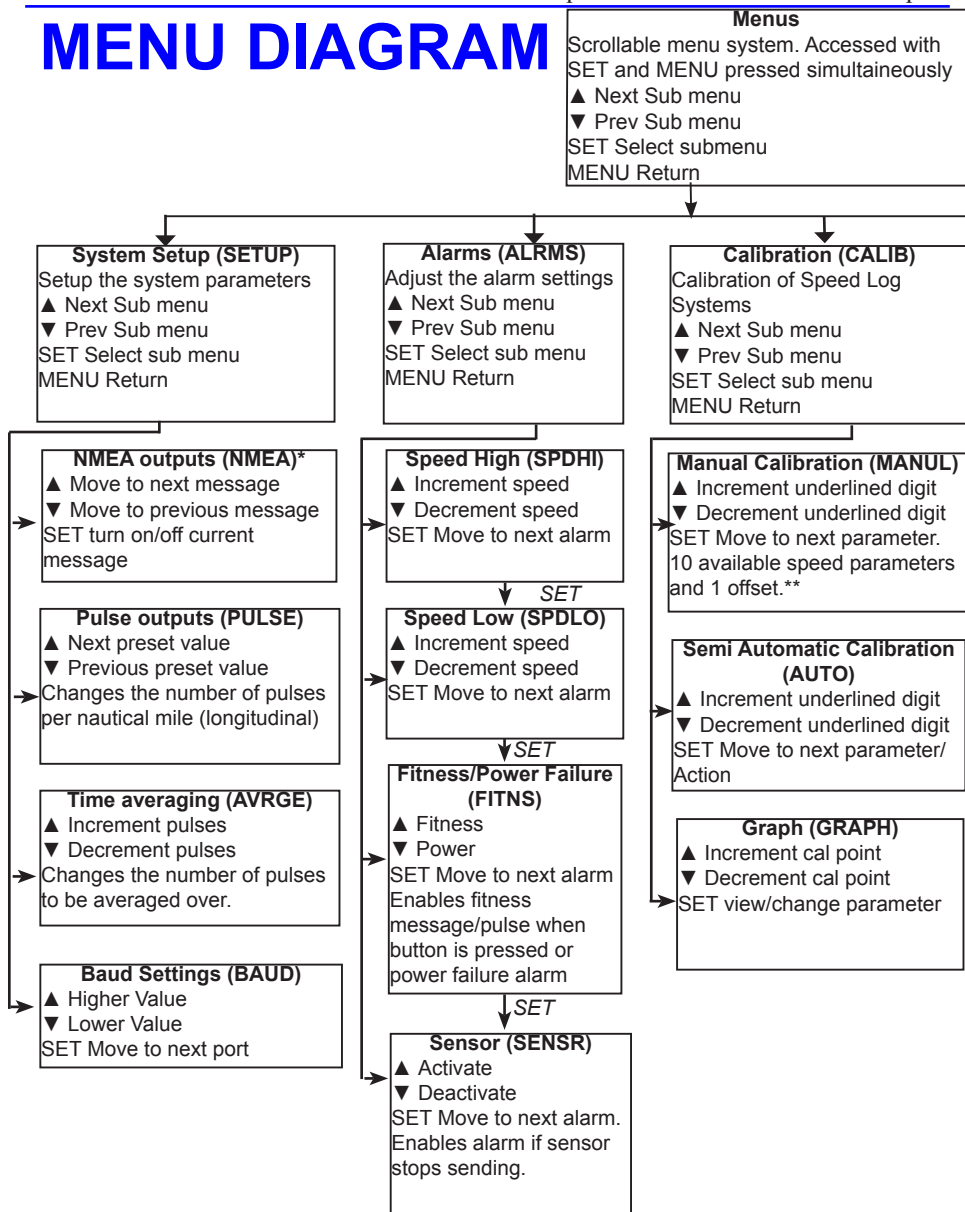

* One option in the NMEA settings is DIAG. This turns on some of the diagnostics outputs. These are propriety messages that occur if an error occurs or if requested. Setting this to 'ON' will stop all other messages.

** Offset calibration not available in single axis system.

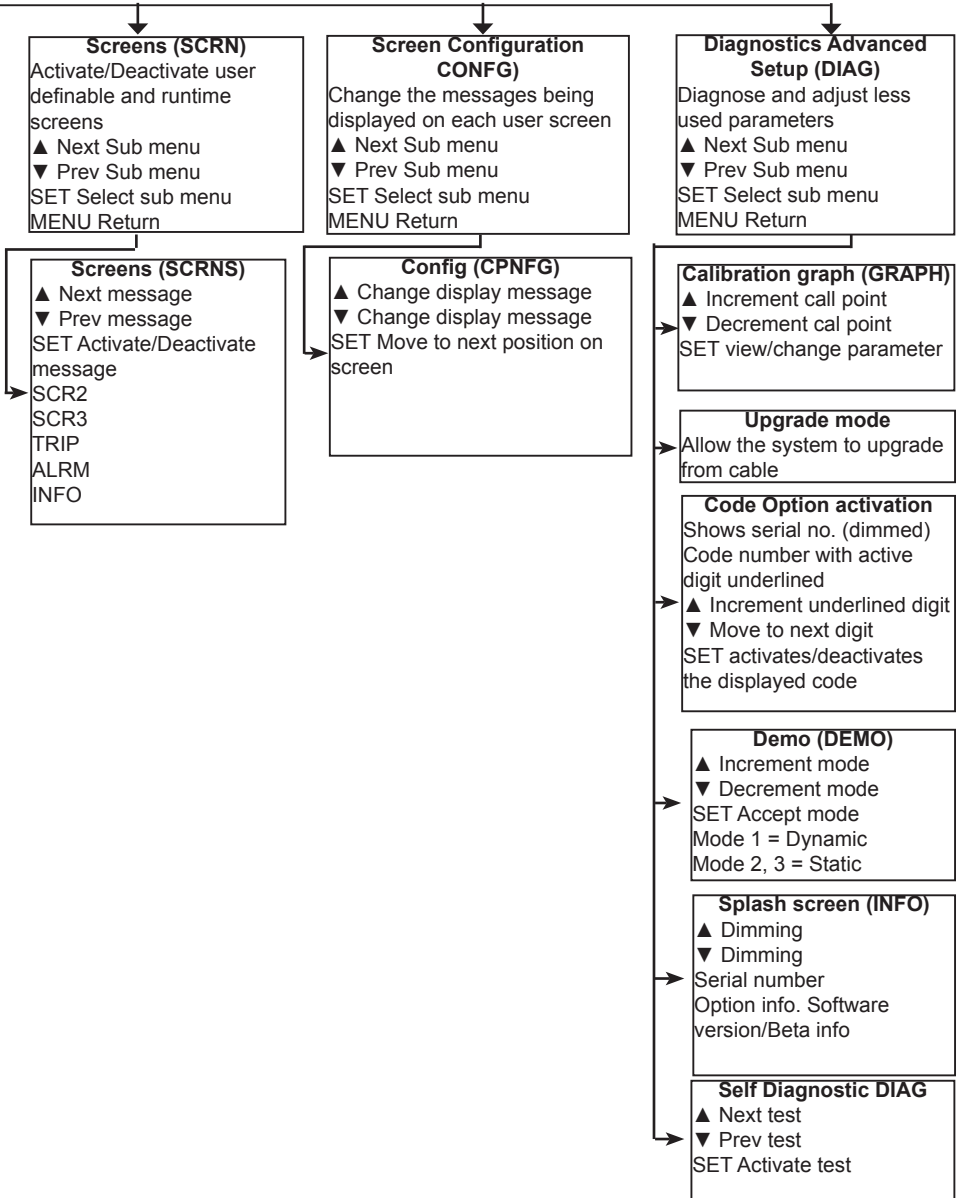

NOTES:

SKIPPER